

EV Charging Solutions

Wireless Modules
Passive & Emech components
Thermal management



PANASONIC EV CHARGING SOLUTIONS

EV Charging Types and Requirements

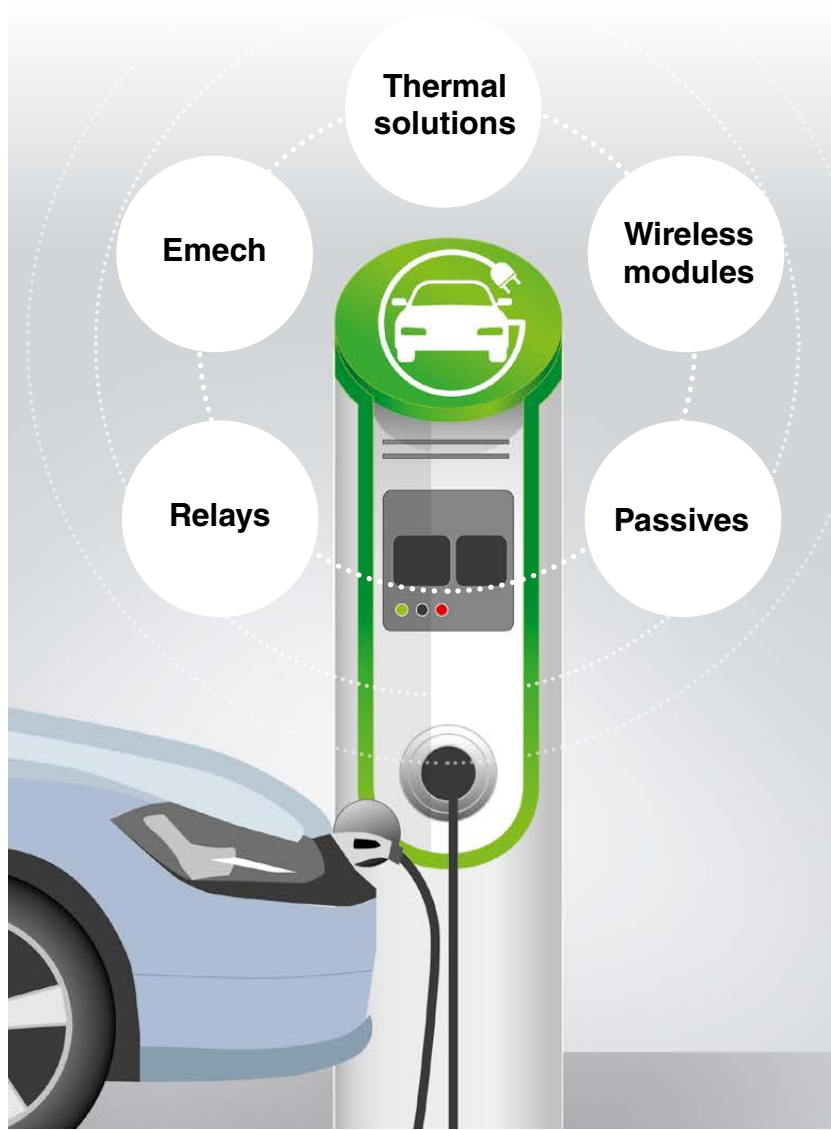

Our mission: **“ Zero failure ”**



Safe, fast & reliable charging – the key driver for successful e-mobility

E-mobility is a core DNA of Panasonic. For decades we develop and supply solutions for all kind of xEVs. To succeed in the mass market, the new technology must be reliable. Customers will not accept failures, neither during driving nor during charging.

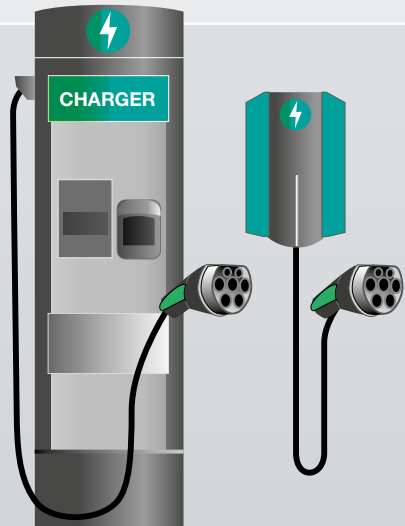
This zero failure mindset motivates us to engineer best in class components & devices for safe, fast & reliable charging technology.

Mode 2 AC charging cable	Mode 3 AC wallbox or charging station – AC to EV	Mode 4 DC wallbox or charging station – DC to EV
Input: 120V AC 1-phase Output: 240V~480V AC ~3kW	Input: 208~240V AC 1-phase Output: 240V~480V AC ~20kW	Input: 380~600V AC 3-phase Output: ~1000V ~150kW
		

WIRELESS MODULES

Combination of Wi-Fi and Bluetooth®



The PAN902x Series perfectly connects the charging station with mobile devices or a cloud.

For commissioning and displaying usage data by a smartphone or a similar handset, wireless modules serve as access points or clients. With its combination of Wi-Fi and Bluetooth® function, the PAN902x Series provides the highest flexibility for connectivity, depending on which data rates or ranges are required for an EV charger application. The PAN9026, a dual band 2.4/5 GHz 802.11 a/b/g/n Wi-Fi radio module with integrated Bluetooth® BDR/EDR/LE is specifically designed for highly integrated and cost effective applications, whereas the PAN9028 is targeted for more sophisticated use cases where higher data rates (802.11ac) are needed. The PAN902x can act as a client to connect the charging station to a network, in order to upload data to a cloud.

Load Balancing

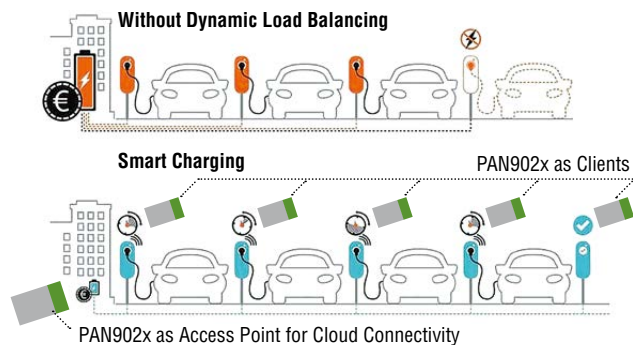

PAN9026

- » Dual band 2.4/5 GHz 802.11 a/b/g/n Wi-Fi/BT combo module
- » Bluetooth® 4.2 (includes LE) as well as future Bluetooth® 5.0 features
- » Supports 802.11i security standards through AES, CCMP, and more security mechanisms
- » Dual simultaneous and independent WLAN and Bluetooth® operation
- » IEEE 802.11n 20 MHz and 40 MHz channel bandwidth
- » Wide temperature range of -30 to +85°C

Private Wallbox	Professional DC Charging Station
Usage data	
Uploading usage data to a cloud	Uploading commercial data to a cloud
Monitoring	
Tracking of vehicle's state of charge or storage capacity	Tracking of vehicle's state of charge or storage capacity, occupancy and expected availability of the various charging stations
Maintenance	
No technical staff needed locally for maintenance	On site technician can access maintenance data remotely, thus saving material costs
Smart charging	
No smart charging needed	Load Balancing by taking storage capacity, occupancy and vehicles' state of charges into account thus saving you from costs of expensive grid upgrades.

WIRELESS MODULES

Bluetooth® LE Solution



Just integrate PAN178x series “” access charging station data.

PAN178x are Bluetooth® Low Energy modules based on Nordic Semiconductor chipsets, particularly suitable for low-power transmission of smaller data rates. The wireless modules differ only in memory size and number of GPIOs to meet various application requirements.

In commercial DC charging stations, the PAN178x modules can be integrated into a meshed network, which not only allows customers to connect easily, but also gives the operator an overview of the individual charging stations in terms of occupation. The SoC offers a qualified Bluetooth mesh stack with all mandatory and optional features in addition to a wide range of applications.

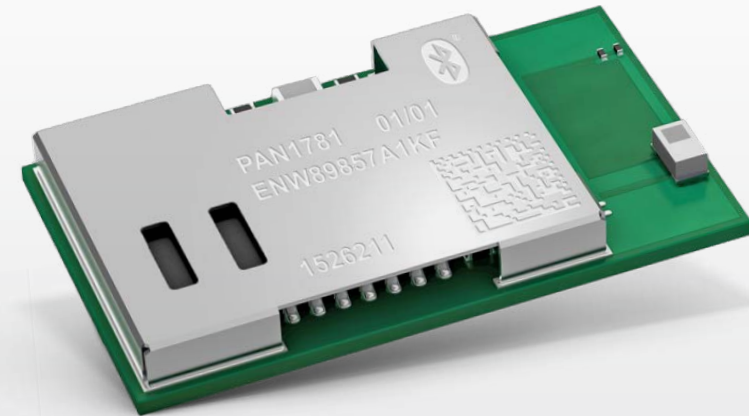
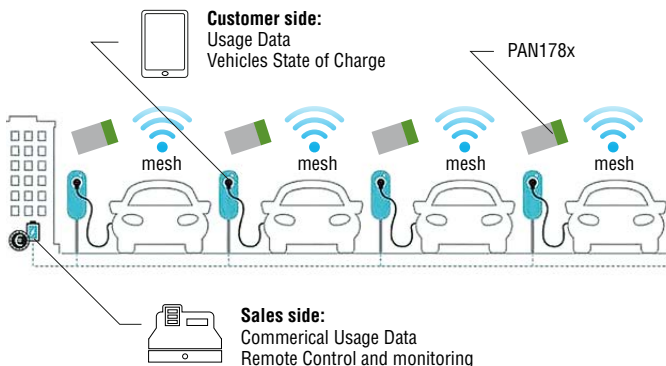

PAN178x



- » IP Core: Cortex M4(F) with 64 MHz
- » Temperature Range: -40 to 85
- » Size: 15.6x8.7x2mm
- » Up to 48 General Purpose I/Os (depending on module version)

PAN1781	PAN1782	PAN1780
256 kB Flash 32 kB RAM 64 MHz	512 kB Flash 128 kB RAM 64 MHz	1 MB Flash 256 kB RAM 64 MHz

Under development. Contact us:
wireless.connectivity@eu.panasonic.com

POLYMER CAPACITORS

Perfect for AC/DC and DC/DC Converters

Tough against temperature
fluctuations, perfect for
outdoor installations.

These advanced capacitors use conductive polymers to form the electrolyte, or the conductive polymers can be used in conjunction with a liquid electrolyte in a design known as a hybrid capacitor. Either way, these polymer-based capacitors fulfill the high endurance and temperature requirements of EV charging stations. In addition, due to polymerization and having high conductivity, such applications benefit from a very low ESR which is needed for power stabilization.

Temperature Range

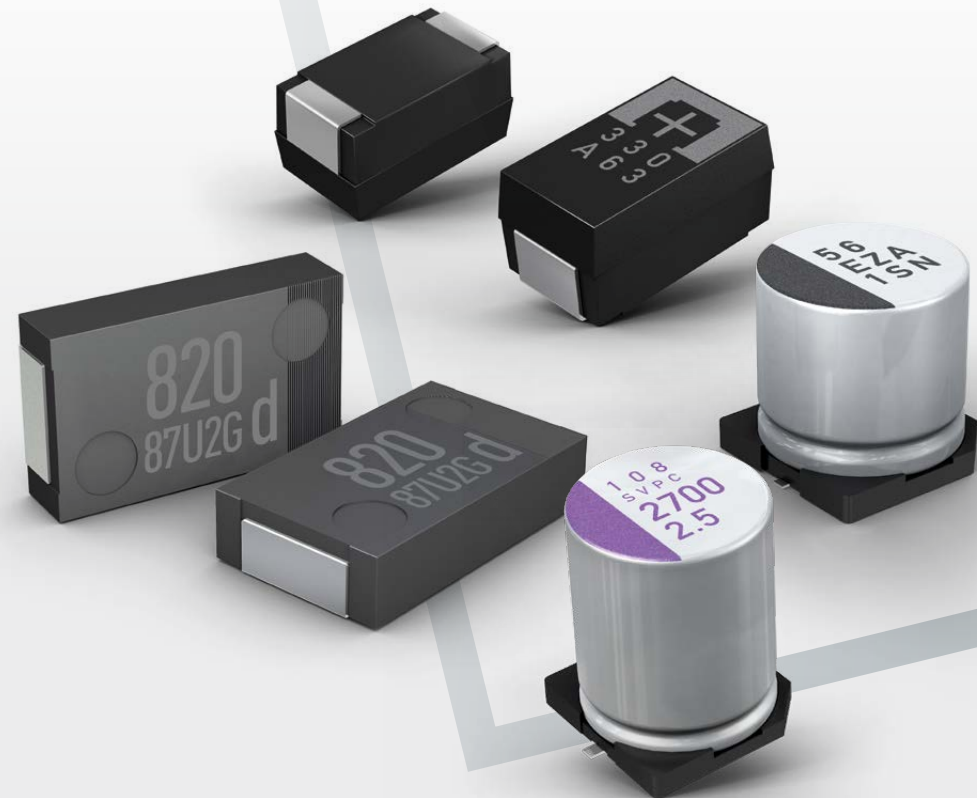
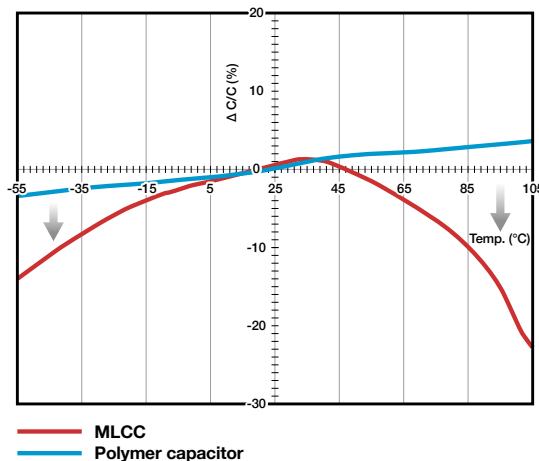

- » Ultra-low ESR for power stabilization (down to 3mΩ)
- » Long endurance at high temperature, 20,000h @105°
- » High reliability for outdoor usage
- » AEC-Q200 compliant
- » High temperature resistance up to 150°C

Open
Whitepaper

FILM CAPACITORS

High Safety by Integrated Fuse Function

Zero risk for safety and high resistance against moisture.

The outstanding feature of Panasonic's film capacitors is the integrated safety function. An original in-house patterned metallization process is the basis of a special structure serving as a fuse mechanism function that prevents from short mode failure. Additionally, it achieves a very stable capacitance level over the capacitor's lifetime and therefore guarantees a high reliability. Furthermore, long lifetime is realized by high temperature & moisture resistance using originally developed sealing technology.

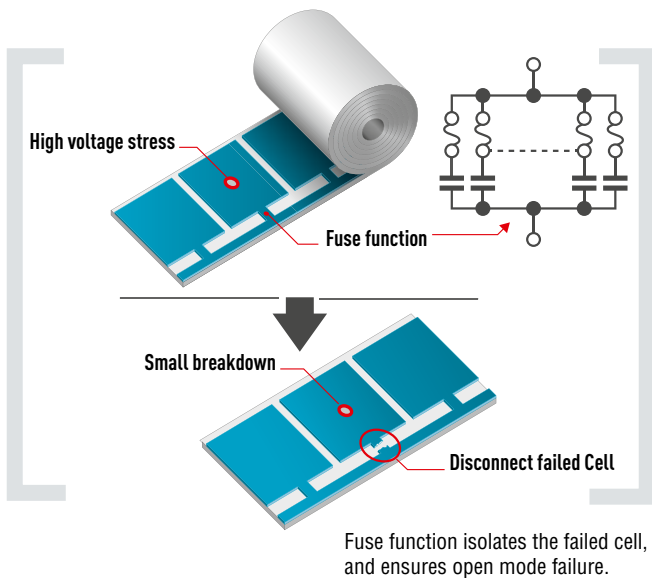

- » Rated voltage 275VAC to 310VAC (EMI suppression), 600VDC to 1,100VDC (DC smoothing)
- » 0.0082 μ F to 10 μ F (EMI suppression), 3 μ F to 110 μ F (DC smoothing)
- » -40°C to 110°C
- » AEC-Q200 compliant (Automotive part numbers only)
- » Built-in fuse function
- » High moisture resistance
- » Flame retardant plastic (case and sealing resin)



POWER CHOKE COILS

Metal Composite Magnetic Core Technology for Outstanding Reliability

Space saving high-tech



with zero failures.

Best-in-class reliability for the automotive industry market the metal composite power inductors ETQP-series. The monolithic core and innovative terminal structure guarantee high resistance against thermal stress and vibrations. Unique is the magnetic core material which provides none hard saturation characteristics against D.C. bias current for high peak current capability, and also can reduce D.C. Resistance and A.C. Resistance for low power loss.

This in turn supports higher power efficiency in DC-DC converters and input filter circuits, as well as a possible space reduction of up to 50% against ferrite inductors.

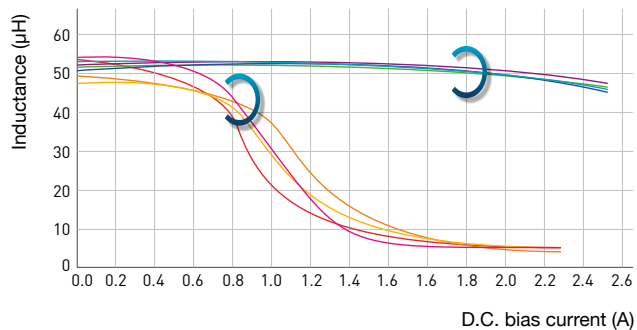

- Ferrite Type (25°C)
- Ferrite Type (100°C)
- Ferrite Type (125°C)
- Ferrite Type (150°C)
- Panasonic (25°C)
- Panasonic (100°C)
- Panasonic (125°C)
- Panasonic (150°C)

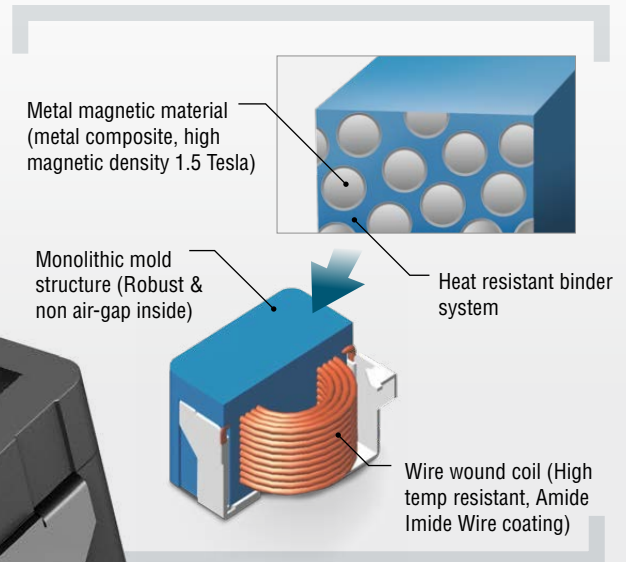

- » Variety of inductance range from 0.33µH to 100µH
- » Package size from 5x5mm to 12x12mm
- » Up to 85A saturation, 53A rated / 0.33µH
- » Operation temp. -55°C to +155°C, up to +180°C in short time
- » 50% space saving vs Ferrite inductor
- » Vibration resistance from 10G to 30G
- » AEC-Q200 compliant



CHIP RESISTORS

Enhancing Solder Joint Reliability by Soft Termination

Our mission: Zero **“**
” solder joint cracks

Panasonic offers a wide range of resistors, designed and tested to be used in a variety of applications. All of Panasonic resistors use soft termination technology. This means that by using a soft resin, the solder joint experiences less stress in temperature cycles and therefore, ensures minimum risk of solder joint cracks.

EV Charging – recommended series

- » High temperature thick film chip resistors (ERJH series)
- » Anti-surge thick film chip resistors (ERJP series)
- » High power wide terminal thick film chip resistors (ERJB and ERJD series)

Without soft resin

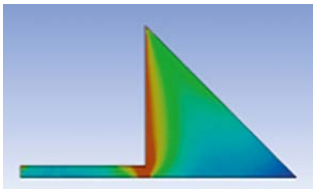

Risk of solder crack because of high stress

With soft resin (Panasonic)

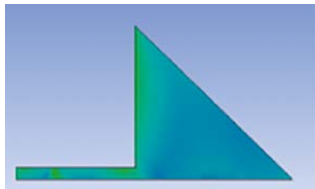

Less risk of crack because of soft termination → high solder-joint reliability



- » **Soft termination technology for highest solder-joint reliability**
- » **Resistance values from 1 mΩ to 10 MΩ**
- » **High precision by tolerance as low as 0.05% and TCR as low as 10 ppm/K**
- » **High temperature up to 175°C**
- » **AEC-Q200, RoHS, and REACH compliant**
- » **Anti-pulse and anti-sulfur types available**

[Go to Product Page](#)

RELAYS AS A MAIN SWITCHING ELEMENT

Handle up to 22kW of Charging Power Directly on the PCB

New HE-R relay is the first
3 phase switching solution
for direct PCB mounting.

AC switching elements are a crucial part of safety and protection function in charging stations and cables. Key parts of the HE line-up are the 35A HE-S with two contacts and 40A HE-R relay with four contacts. Both types are available with a mirror contact according to IEC 60947-1 and VDE / UL approvals. They can be used in the latest generation of wallboxes which fulfill either IEC 61851-1 or the recent IEC 62955 norm.

Feedback contact construction: HE-S relay

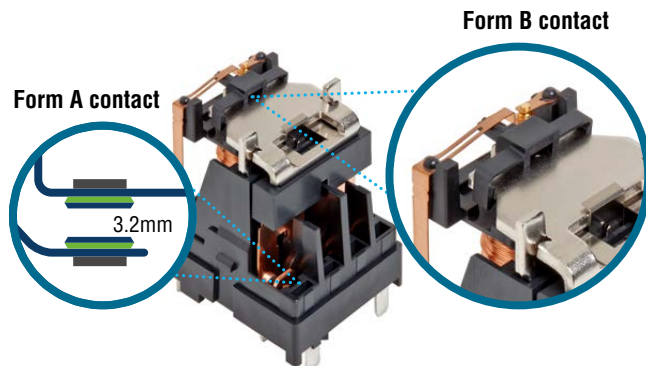

With a gap between normally open contacts of 3.2mm, the HE-S exceeds mandatory regulations.

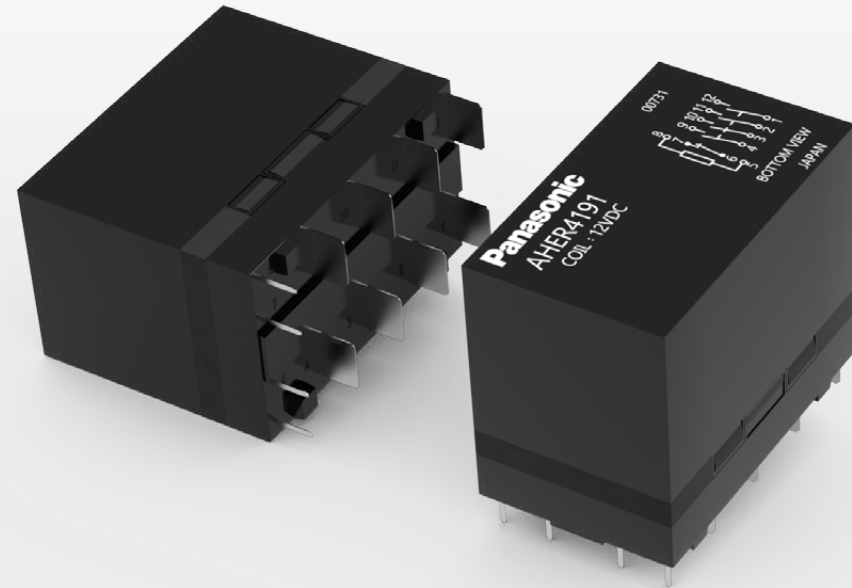

Series	HE-S	HE-R
Switching current	35A AC	40A AC
Contact configuration	2a, 2a1b	4a, 4a1b
Dimensions	30x36x40mm	35x58x47mm
Holding power*	170mW	490mW
Contact gap	3.2mm	3.6mm

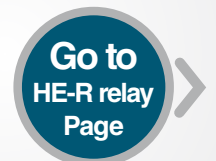

RELAYS FOR CONTROL SIDE

Galvanic Isolated Relays for Signaling and Locking

Realize an isolation of
1,500V in a small
SOP6 housing.

Beside the power line, charging stations include a lot of systems for communication, system control, safety functions and HMI. Wherever switching must be electrically separated from the control circuit, electromechanical or optocoupled semiconductor PhotoMOS® relays are used. AQY series, for example, is used in charging station battery storage systems to isolate internal from external signals. Contact us directly to find the perfect fit for your need quickly – and save hours of internet investigation.

PhotoMOS® relays realize galvanic isolation by an LED that emits light through an isolator to a solar cell. The solar cell drives the MOSFET output.

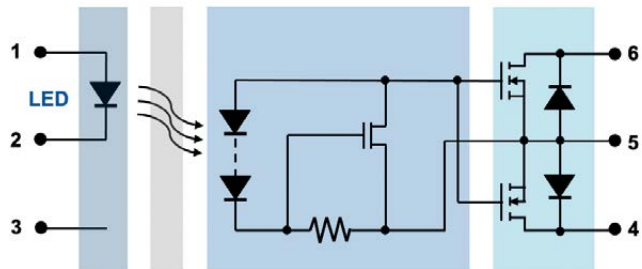

Feature	PhotoMOS®	Signal Relay
Signal transfer	++	++
I/O Galvanic Isolation	++	+
Output Separation	0	++
AC/ DC Switching	+	+
Control Power	++	0
Load Voltage	++	+
Load Current	+	+
Stable On Resistance	++	0
Overload withstand	0	+
Switching noise	++	0
Size	++	0



GRAPHITE THERMAL INTERFACE MATERIAL

Extends Product Lifetime with High Reliability Properties

Just apply and benefit the “ long term reliability effect.

GraphiteTIM, a Panasonic exclusive material using highly crystallized graphite, transfers heat generated from a power device to a heat sink with excellent thermal conductivity. In addition, the high compressibility effectively fills the voids between the heating and the cooling device to achieve even lower low thermal resistance. Compared to grease, GraphiteTIM has a stable heat dissipation for a long period of time due to no deterioration and pump out effect.

High reliability (power cycle test)

Junction temperature remain stable for a long period of time.

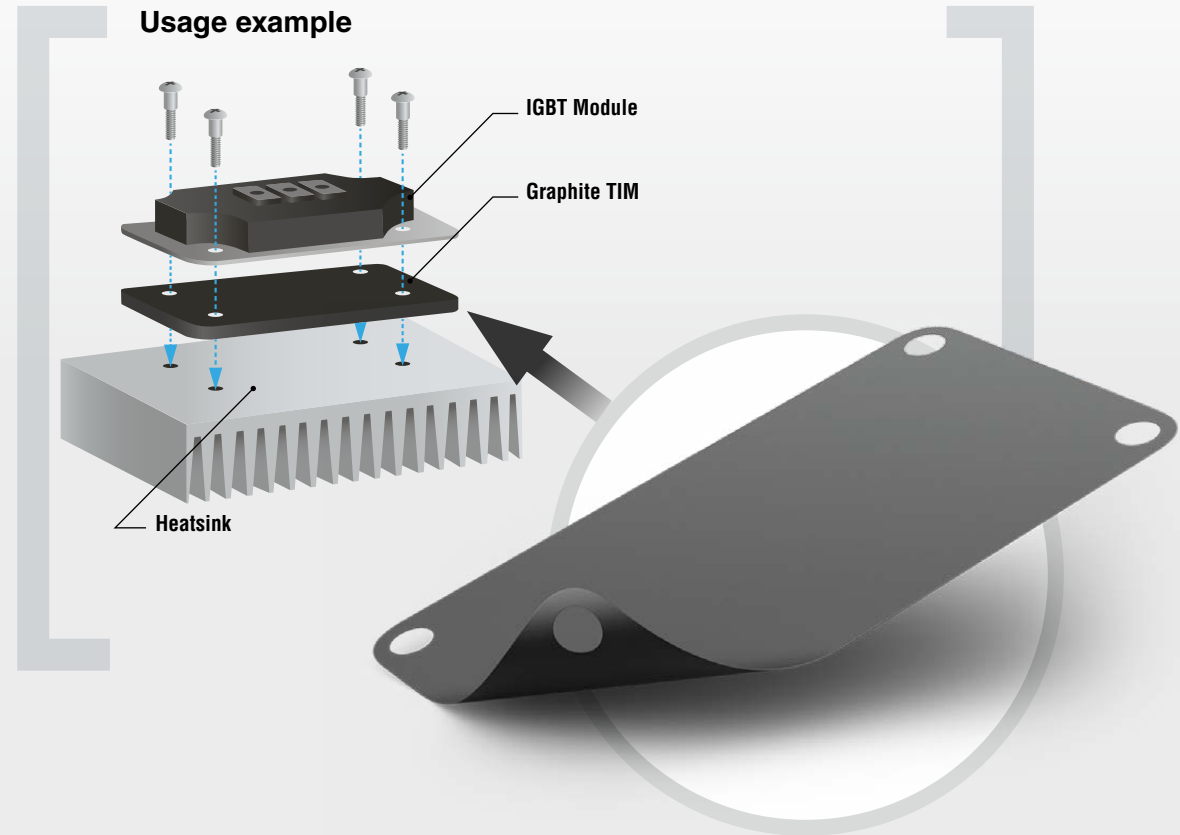
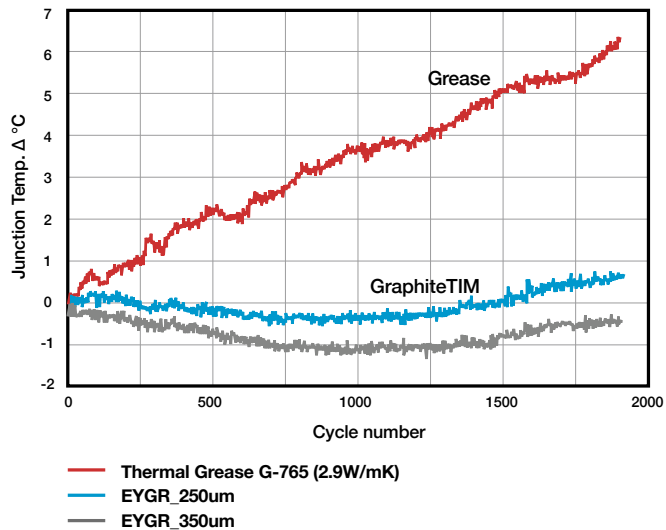

- » Low thermal resistance (ASTM D5470 at 0.6MPa) 0.2 K • cm²/W*
- » High Compressibility (ASTM D5470 at 0.6MPa) 40%*
- » High reliability (stable junction temperature)
- » Operating temperature -55 to +400 °C
- » Easy handling and easy to install

* Measuring device TIM Tester ANALYSIS TECH, ASTM D5470 compliant)



SEALED MICRO SWITCHES

IP67 Slide Switches for Rough Conditions and Limited Space

New ASQMR series integrates resistor-based detection of lead wire break and short circuit.

Safety is an important requirement in EV applications. ASQM switches are used e.g. to detect if a lid or cover plate of the high voltage part is open. The control of the charging station can use this signal to prevent the system of an unintended activation or perform an emergency shutdown for protection against accidental contact.

An even higher grade of safety and reliability offers ASQMR series. By integrated chip resistors, failure modes like lead wire break and short circuit can easily be detected.

Comparison of detection results between conventional and resistor installed switches.

Without Resistor

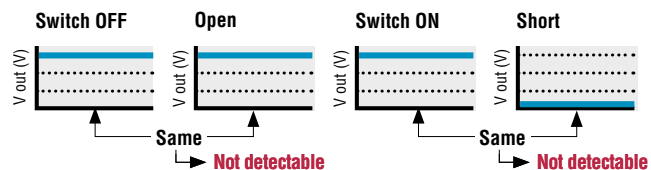

Resistor installed

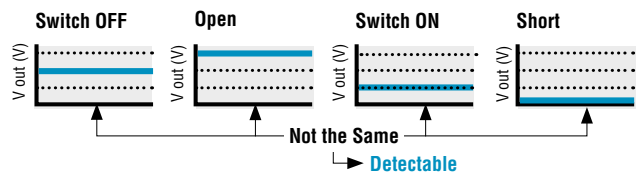

ASQM series:

- » Contact form SPST
- » Soldering or fork terminal
- » Silent operation with sliding contact
- » Long stroke
- » Excellent shock and vibration resistance
- » Waterproof – IP67 degree of protection
- » Insertion lever with high reset force

Additional features ASQMR diagnostic series:

- » 2012 chip resistor (0.5W 70°C)
- » Smallest diagnostic switch on the market

Go to
Product
Page

CONNECTORS

Board to FPC / FFC Connection

CF1/CF2 directly connects **“**
” BMS without relay harnessing.

To increase the charging speed and relieve the power grid, future charging stations will re-use EV car battery packs. CF1/CF2 series of Board to FPC connectors give a smart & robust connection in battery management systems with only two parts, a plug and a receptacle. This saves time, money and space.

For connecting displays with keyboard or touch function with the control board, Y5B Series as FPC and FFC connector can be used. The low profile typ enables slim product designs which is especially requested for private wall boxes. To reduce production time and efforts, Y5B is delivered with opened levers.

Comparison of connection methods of board and FPC in Battery systems

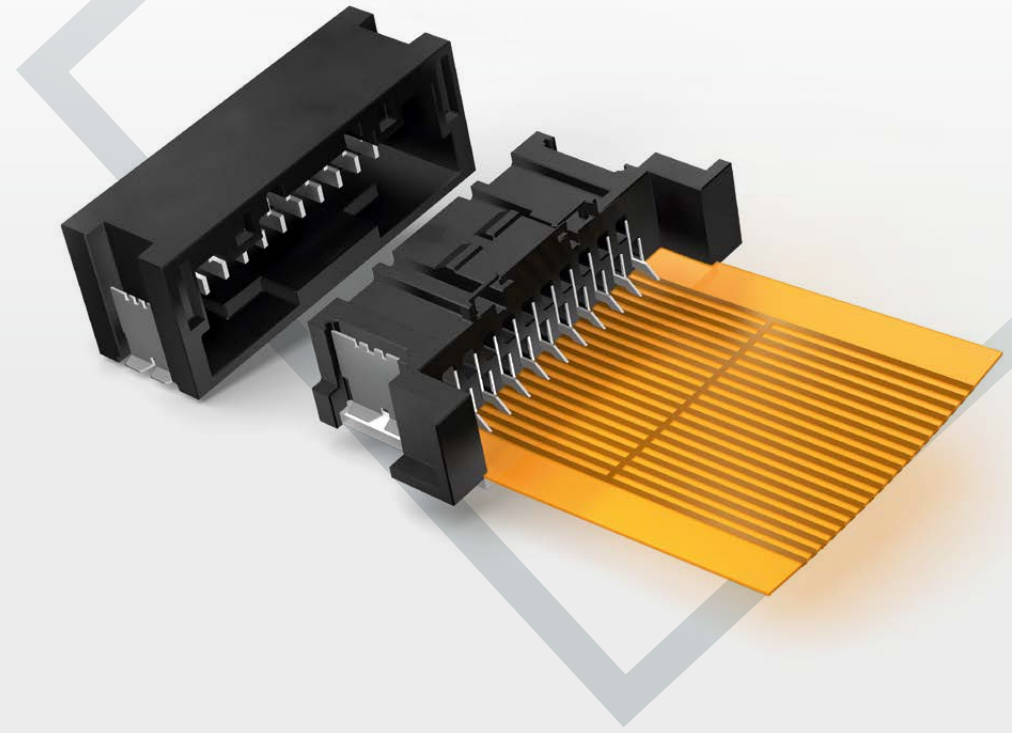
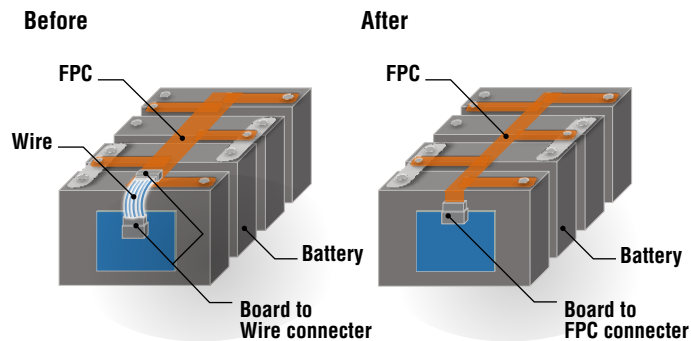

- » For Automotive applications, 125 °C heat resistance
- » Contact reliability is preserved by double-sided contact structure
- » Weight and process cost reduction
- » ‚Anti-misoperation bridge structure‘ prevents unintended operation of mating lock
- » Inertia lock construction prevents half-mating



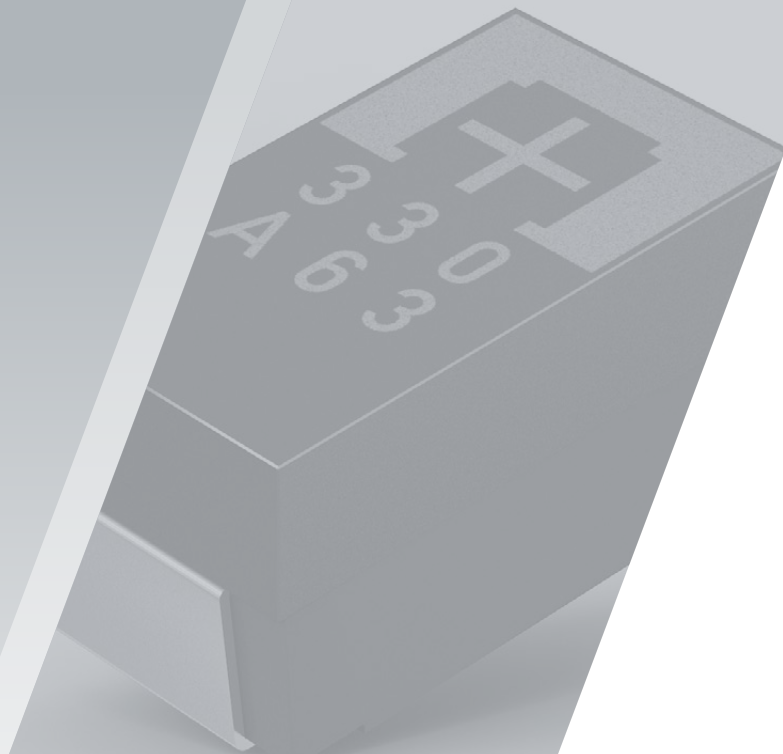

Panasonic Industry Europe GmbH

Caroline-Herschel-Strasse 100

85521 Ottobrunn

Tel. 49 89 45354-1000

info.pieu@eu.panasonic.com

industry.panasonic.eu

Panasonic[®]